



6752 Series Circuit Breakers

Ambient Compensated Single & Three Phase High Short Circuit Capacity

Features

- Useable on large electrical systems – 6000 amperes interrupting capacity
- Circuit protection unaffected by temperature fluctuation – ambient compensated from -65°F to +250°F
- Only faulted line circuits opened – coordination of ratings ensures that branch circuit breakers trip first under fault conditions
- Long trouble-free operation – 20,000 operating cycles
- Military approved
- High amp devices available (65A & 90A)



Overview

The Klixon 6752-12 and -300 series thermal-magnetic circuit breakers are ambient compensated and trip-free. They are designed and manufactured to meet the more stringent military standards of today's jet aircraft, specifically MIL-C-22715 (USAF).

The higher short circuit capacity, vibration resistance and longer cycling life of the 6752-12 and -300 series exceed previous military standards. In addition, the 6752-12 and -300 series provide ambient compensation, fault coordination of all ratings, and an option for auxiliary circuits.

High Short Circuit Capacity

A deionizing grid and magnetic assist enable the 6752-12 and -300 series to successfully interrupt four fault currents of 6000 amperes – two at sea level and two at 60,000 feet – on either a 120 VAC, 400 Hz system or a 30 VDC system.

Ambient Temperature Compensation

Substantially unaffected by ambient temperature, the 6752-12 and -300 series circuit breakers maintain their performance capabilities by means of a thermal compensator in the temperature range of -54°C to +121°C.

Coordination

The 6752-12 and -300 series breaker ratings are coordinated so any rating will trip before another rating, twice its capacity, in the event of a fault. This results in improved over-all equipment performance, since only the smallest faulted circuit is removed while larger circuits remain in operation.

Auxiliary Circuit

The 6752-12 and -300 series are available with auxiliary switch. For part numbers and characteristics, please consult the factory.

MIL Qualification

TI Number	MS Number	
6752-12-2½	MS 24571-2	MS 24571-2V
6752-12-5	MS 24571-5	MS 24571-5V
6752-12-7½	MS 24571-7	MS 24571-7V
6752-12-10	MS 24571-10	MS 24571-10V
6752-12-15	MS 24571-15	MS 24571-15V
6752-12-20	MS 24571-20	MS 24571-20V
6752-12-25	MS 24571-25	MS 24571-25V
6752-12-35	MS 24571-35	MS 24571-35V
6752-12-50	MS 24571-50	MS 24571-50V

When ordering MS 24571-XX(V) style breaker by TI part number, designator must include S.R. 12507-356

Example: 6752-12-2½ is S.R. 12507-356

Characteristics

6752

6752-12

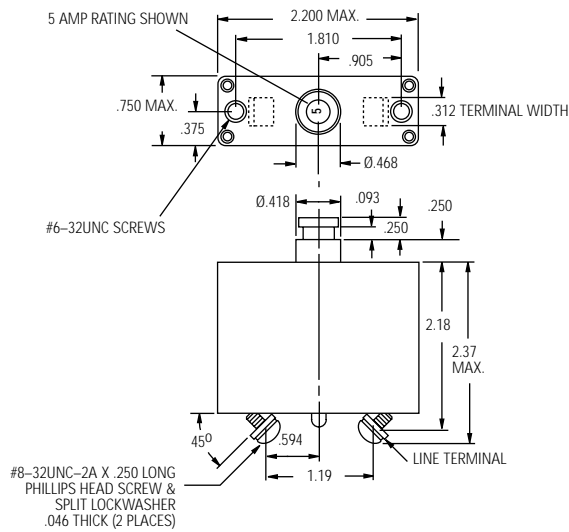

6752-305

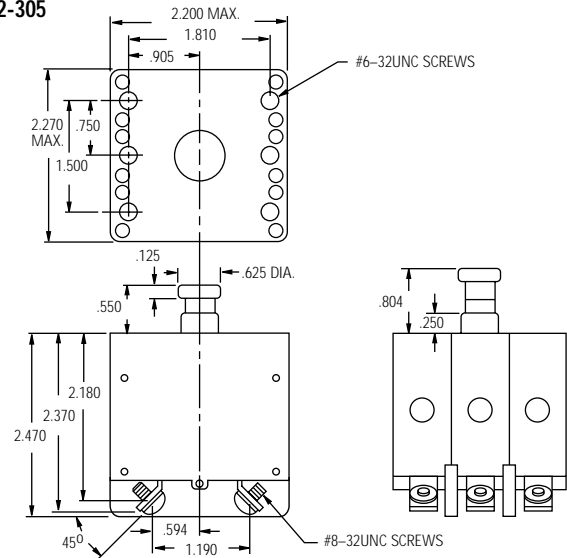

6752-12 Calibration: 2½ - 50 amps

TI Part Number	200%	400%	1000%
6752-12-2½	12-32	2.3-6.5	.32-1.1
6752-12-5	14-36	2.5-6.5	.45-1.1
6752-12-7½	16-40	2.5-7.0	.34-1.1
6752-12-10	18-42	2.7-7.75	.45-1.2
6752-12-15	20-45	2.7-8.0	.36-1.2
6752-12-20	20-48	2.7-8.0	.36-1.2
6752-12-25	20-50	2.7-8.0	.36-1.2
6752-12-35	20-53	2.7-9.5	.36-1.2
6752-12-50	20-55	2.7-8.0	.36-1.4

6752-305 Calibration: 2½ - 50 amps

TEMP °C	MIN ULT TRIP	MAX ULT TRIP	TRIP TIME - SECONDS		
			200%	400%	1000%
+25	110%	138%	12-65	2.3-10	.33-1.4
-54	110%	160%	15-65	2.3-10	.33-1.4
+93	105%	138%	12-65	2.3-10	.33-1.4
+121	100%	138%	12-65	2.3-10	.33-1.4

† Single phase max. ult. trip values apply with other two phases carrying 100% of rated current.

TI Part Number		Voltage Drop Max**
Single Phase	Three Phase	
6752-12-2½	6752-305-2½	0.60
6752-12-5	6752-305-5	0.40
6752-12-7½	6752-305-7½	0.30
6752-12-10	6752-305-10	0.25
6752-12-15	6752-305-15	0.25
6752-12-20	6752-305-20	0.25
6752-12-25	6752-305-25	0.25
6752-12-35	6752-305-35	0.25
6752-12-50	6752-305-50	0.25

** Max voltage drop at nominal rated current.

Performance Characteristics

Vibration* 10 G's minimum, 50-2000 Hz
 Mechanical Shock 25 G's
 Acceleration 10 G's
 Weight 6752-12 - 91 gm max.
 6752-305 - 292 gm max.

Interrupt Current

2½ - 50 amps: 6000 amps at 30 VDC (6752-12 only)
 2½ - 50 amps: 6000 amps at 120 VAC, 400 Hz
 2½ - 50 amps: 4200 amps at 205 VAC, 400 Hz

Endurance

5000 cycles 120 VAC, 400 Hz Inductive
 5000 cycles 120 VAC, 400 Hz Resistive
 10,000 cycles Mechanical, no load
 20,000 cycles Total

* Other vibration levels available. Contact factory for details.

Approximate Time-Current Curves 6752 Circuit Breakers

